

WE BUILD SOLUTIONS





Hydroflex waterproofing products are used in waterproofing applications in the construction industry. PVC waterstop tapes providing critical solutions in customized details, TPE dilatation tapes, water-swellable acrylic and TPE gaskets, polyurethane sealant, epoxy adhesive and insulation pressure profiles.

INDEX



Hydroflex Waterstop

Sayfa

1-12



Hydroflex Water Swellable Tapes

Sayfa

13-15

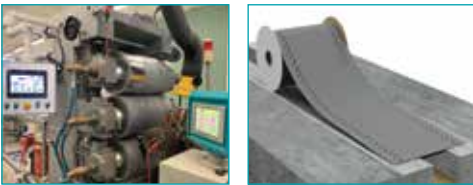

Chamfer Tapes & Dilatation Tapes

Sayfa

16-18



Hydroflex Polyurethane Sealant

Sayfa

19



Insulation Pressure Profiles

Sayfa

20-21



HYDROFLEX WATERSTOP

Hydroflex PVC-based waterstop tapes are produced in accordance with TS 3078-1 and TS 3078-2 standards, with the desired mechanical and chemical properties in the sections and dimensions specified.

Hydroflex waterstop tapes are used in joints arranged in concrete or reinforced structures in order to ensure watertightness of horizontally and vertically movable structures.

APPLICATION AREAS

DAMS
 IRRIGATION CHANNELS
 WATER TANKS
 SWIMMING POOLS
 METRO STATIONS
 retaining walls
 RAID BASICS
 CURTAIN WALLS JOINING PLACES
 REINFORCED CONCRETE STRUCTURES
 UNDER THE GROUND WATER LEVEL



TS3078 Formula Specifications

Shore A hardness	75±5
Tensile Strength	≥ 10 Mpa
Elongation at Break	≥ % 275
Tear Resistance	≥ 12 kN / m
Behavior at low temperature: Elongation at break at -20°C	≥ % 200
Mass Residue Ratio	< % 5,00

Economic Formula Technical Specifications

Hardness	TS 1181 ASTM DD2240-05	Shore A	80 ± 5
Intensity	TS 1310 ASTM D 792-08	gr/cm ³	1,43 ± 0,03
Elongation at Break	TS 7201 EN 60811-1 ASTM D 638-08	%	270
Tensile Strength	TS 7201 EN 60811-1 ASTM D 638-08 ASTM D1238-04C	N / mm ² gr/10 dk	13,10

Waterstop gaskets should prevent water from entering or leaving the structure through the joints. Waterstop tapes should not lose their performance under water load and, if necessary, existing water pressure within the planned usage temperature range.

HYDROFLEX WATERSTOP

The thickness of the structural element must be at least the width of the waterstop band or more.
(300 mm concrete thickness is sufficient for 320 mm waterstop tapes.)
(250 mm concrete thickness is sufficient for 240 mm waterstop tapes.)

- ✧ The embedding depth (G) of the waterstop gaskets in the concrete should be at least as much as the concrete cover thickness (T). (Figure 1)
- ✧ The distance between the outer edges of the waterstop tape and the nearest reinforcement around it should be at least 20 mm. (Figure 2)

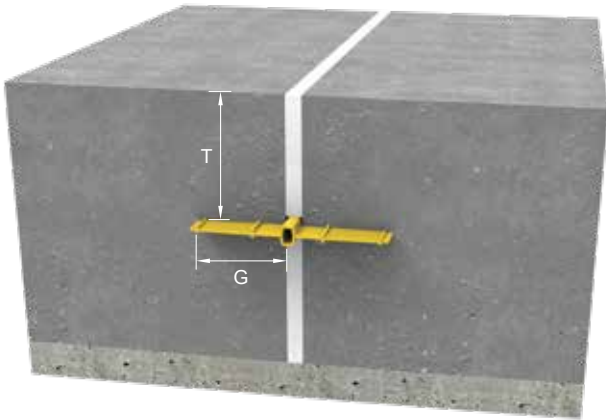

(Şekil 1)

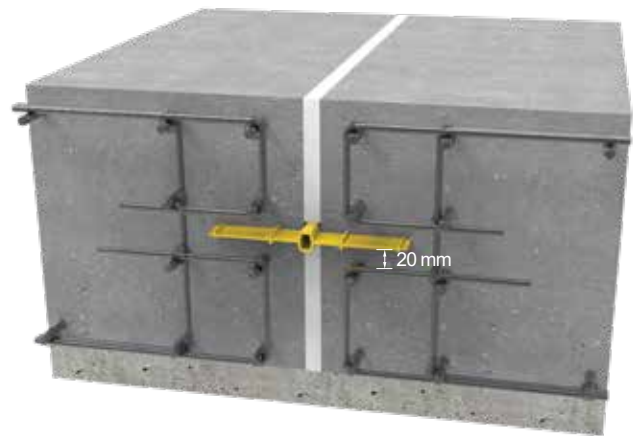

(Şekil 2)

- ✧ If concrete is poured on a part of the waterstop gasket during each construction phase, the exposed part of the waterstop tape should be at least 1 mt.
- ✧ Gaskets (floor or ceiling, etc.) placed in the concrete in horizontal and slightly inclined structural elements should be placed in a slight V shape during concrete pouring. (Figure 3).
- ✧ Waterstop gaskets placed outside the concrete are placed on the side where the water is. These gaskets must be properly protected at all times against mechanical damage to the shear walls.

While the waterstop gaskets placed outside the concrete can carry a load of up to 0.2 bar against unpressurized water on the unnotched side, there must be at least two notched anchor threads on both sides of these gaskets. (Figure 4)

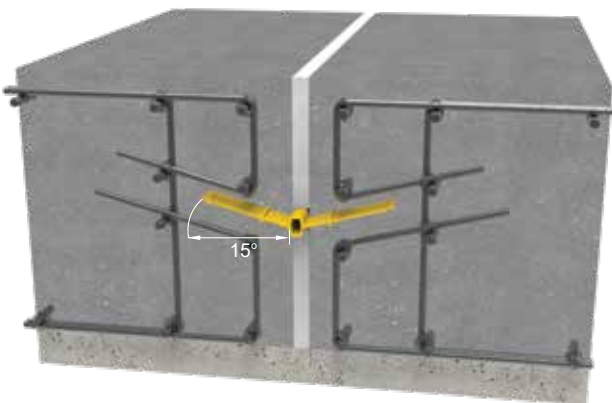

(Şekil 3)



(Şekil 4)

HYDROFLEX WATERSTOP ACCESSORIES



Waterstop Band Welding Machine

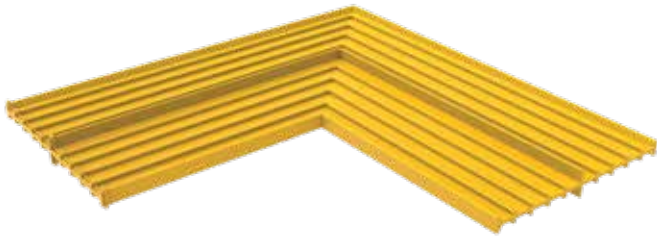
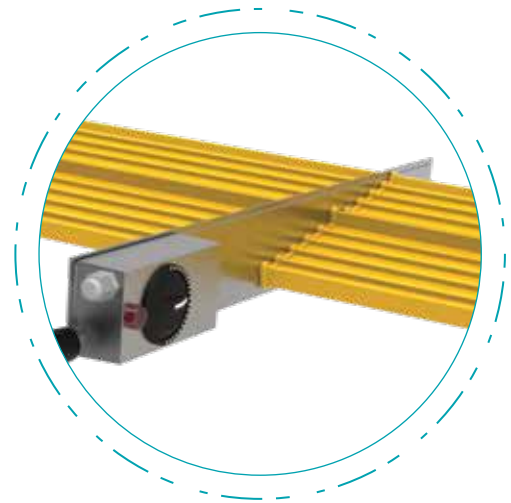

L Corner Bracket

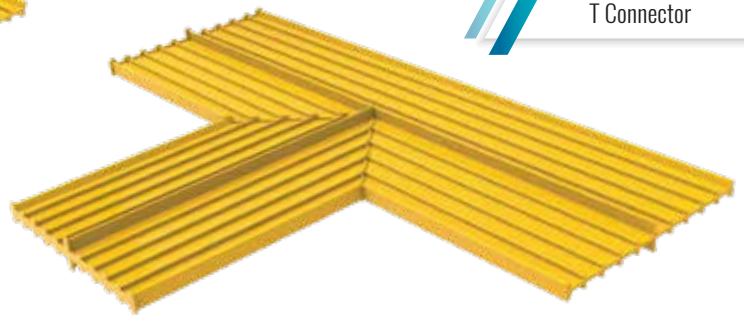

T Connector

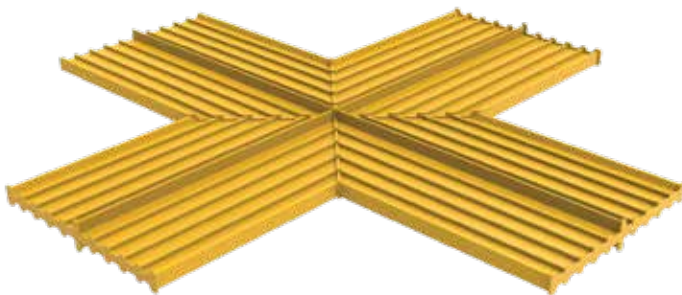

X Connector

SOME IMAGES FROM OUR LABORATORY

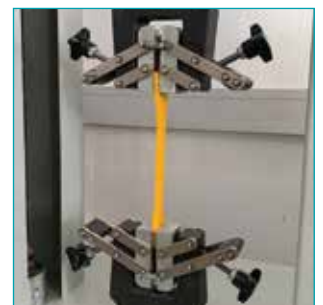

Tensile, rupture tests, aging tests, density and hardness measurements are made continuously in our laboratory.

D TYPE WATERSTOP

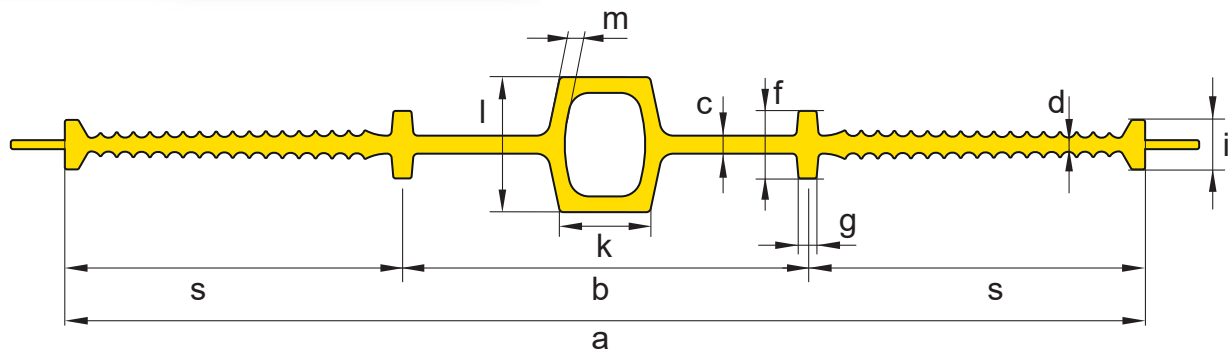

It is an expansion type waterstop tape placed in concrete. In raft - raft combination and curtain - curtain combinations It is used in expansion joints close to the middle of the section. They are produced in three different widths (240, 320, 500 mm). It is called D240, D320, D500.

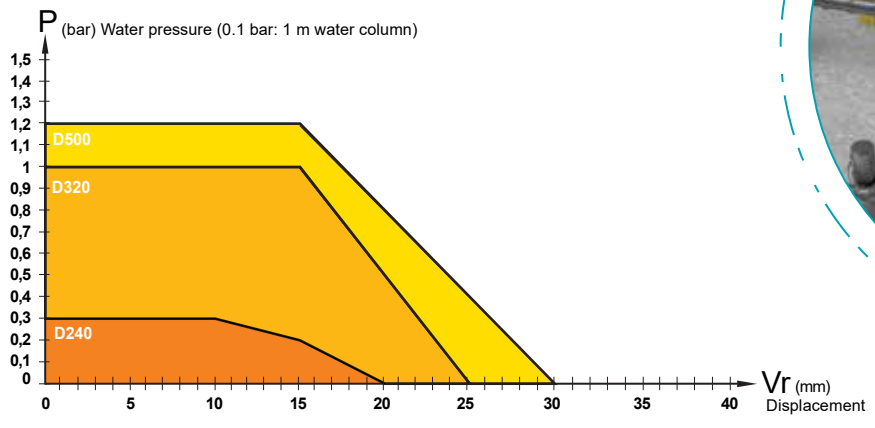
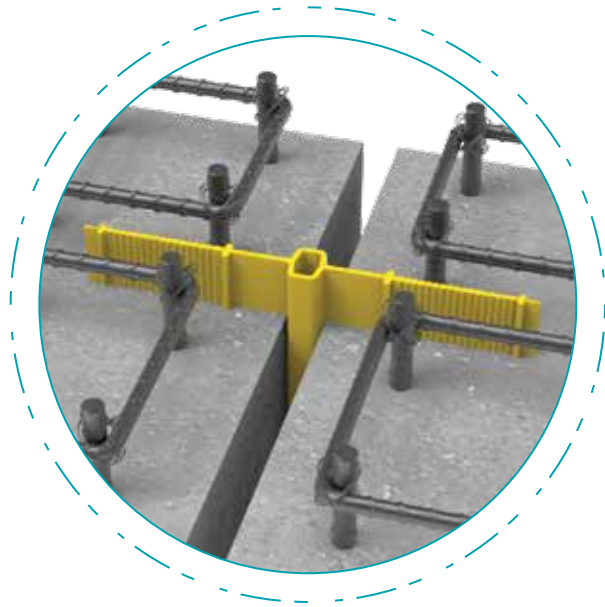

Table 1 - Type D waterstop band seal, nominal dimensions (mm)

Width			Thickness	Profile				Expansion Space		
a	b	s	c	d ^a	f	g	i	k	l	m ^b
least	least	least	least	least	least	least	least	least	least	least
240	80	62,5	4	3	15	≥ c	11 ≥ d + 6	20	30	3,5
320	100	75	5	3,5	35				4	
500	150	100	6	4,5	18 ≥ 3 c	45	4,5			



Taken from TS 3078-1 Table 1, page 8.

A TYPE WATERSTOP

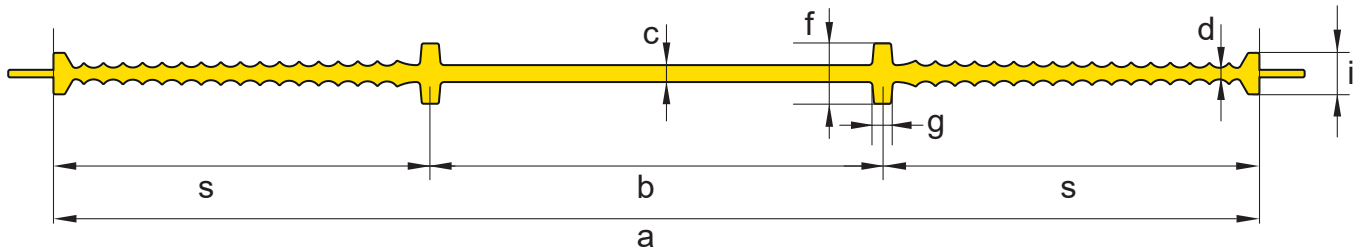

They are the type of waterstop gaskets placed inside the concrete construction element used in joints for raft – raft foundation, raft foundation -retaining wall, retaining wall - retaining wall joints. They are produced in three different widths (240, 320, 500 mm). It is called A240, A320, A500.

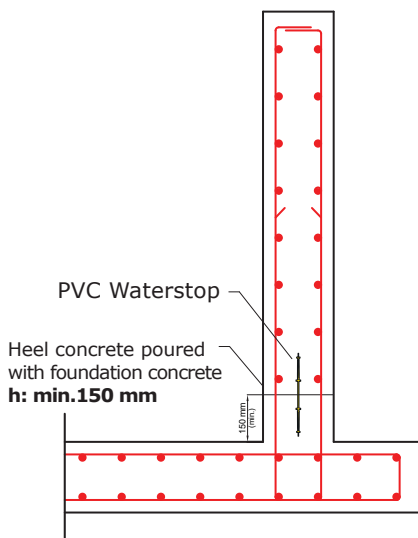

Table 2 - Type A waterstop band gasket, nominal dimensions (mm)

Width			Thickness		Profile		
a	b	s	c	d ^a	f	g	i
least	least	least	least	least	least	least	least
240	80	62,5	3,5	2,5	15	≥ c	11 ≥ d + 6
320	100	75	4,5	3	≥ 3 c		
500	150	100	6	3,5	18 ≥ 3 c		

Sample Application



Taken from TS 3078-1 Table 2, page 8.

DA TYPE WATERSTOP

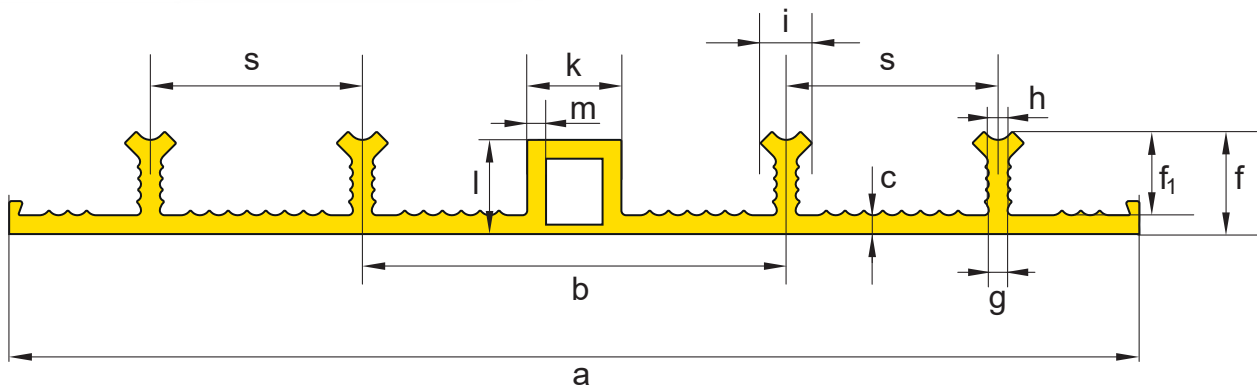

It is a waterstop type with an empty base, and a gap designed in the middle for expansion . Placed on the concrete outer surface.

It has vertical tabs and striped surface on both sides of the tape to extend the water path and increase the water tightness. Produced in three different widths (240, 320, 500 mm). They are named DA240, DA320 and DA500.

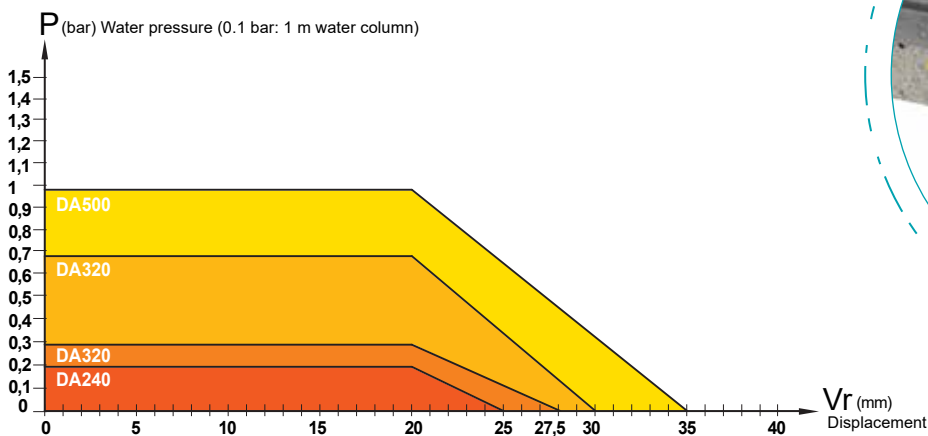

Table 3 - Type DA waterstop band gasket, nominal dimensions (mm)

Width		Thickness	Profile							Expansion Space		
a	b	c	N	e	f	f ₁ ^a	g	h	i	k	l	m
least	least	least	least	least	least	least	least	least	least	least	least	least
240	90	4	4	45	20	16	4	4	11 ≥h+6	20	20	4
320	100		6		25	21	≥c					
500	120		8		25	21	≥0,2f					

Taken from TS 3078-1 Table 3, page 8.

Sample Application



AA TYPE WATERSTOP

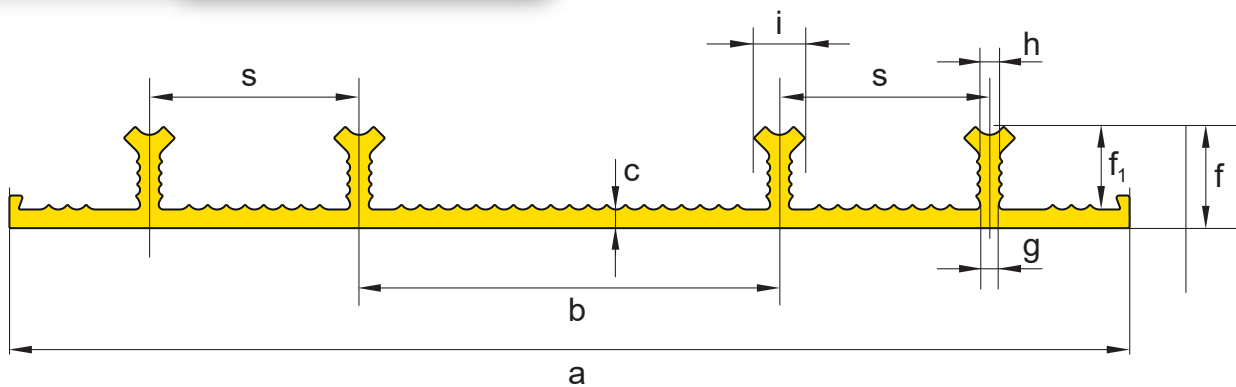

It is a type of waterstop tape that is placed on the concrete outer surface with vertical nails in order to prevent the concrete from peeling off and to increase the water resistance in the gasket. The base is flat and no expansion gap designed in the middle. It is used in partial contraction and full contraction joints in raft construction – raft construction and retaining wall to retaining wall joints. They are produced in three different widths (240, 320, 500 mm).

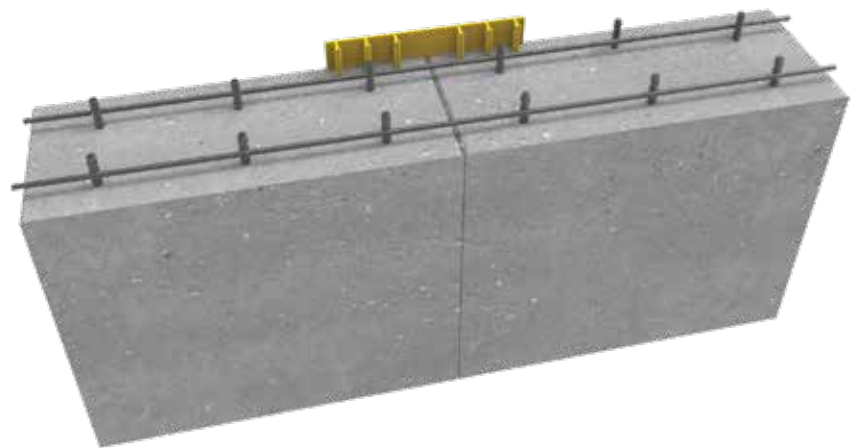

Table 4 - Type AA waterstop tape gasket, nominal dimensions (mm)

Width	Thickness	Profile							
		c	N	e	f	f ₁ ^a	g	h	i
least	least	least	least	least	least	least	least	least	least
240	80	4	4	45	20	16	4	4	11
320	100		6		25	21			
500	150		8		25	21			
							≥c		≥h+6
							≥0,2f		

Taken from TS 3078-1 Table 4, page 9.

Sample Application



FA TYPE WATERSTOP

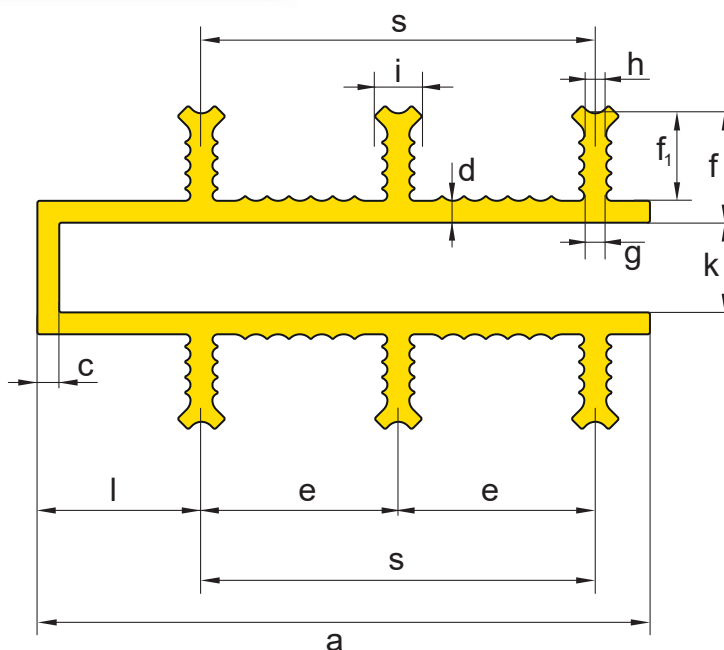

These waterstop tapes designed with a U-shaped cross-section and used when other type of waterstops are not suitable in iron reinforcement applications. Usually placed towards the outer part of the concrete structural element. Hydrostatic compressive strength is slightly lower than other types.

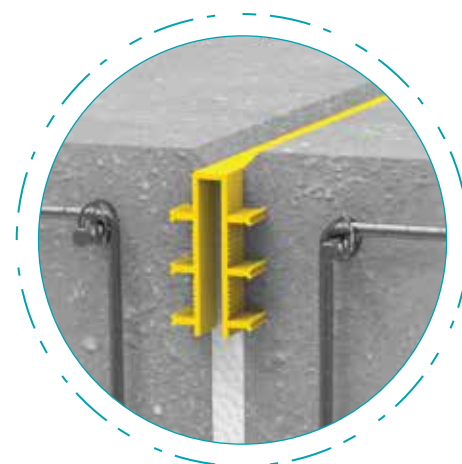
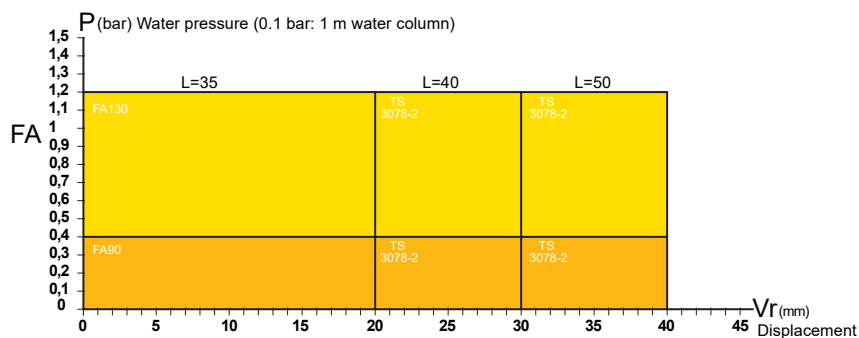
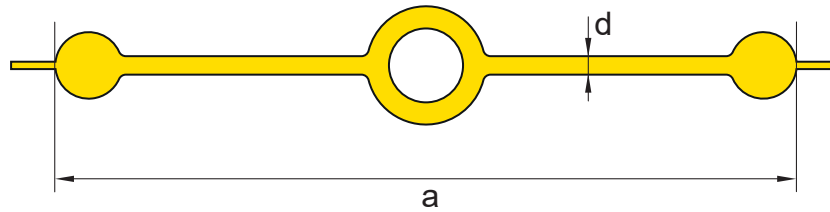

Table 5 - Type FA waterstop band seal, nominal dimensions (mm)

Width		Thickness		Profile						Expansion Space	
a	c	d	N	e	f	f ₁	g	h	i	k	l
least	least	least	least	least	least	least	least	least	least	least	least
50	5	5	2	-	25	20 f-c	5 ≥d ≥0,2f	4	11 ≥h+6	20	35
90			4								
130			6								

Taken from TS 3078-1 Table 5, page 9.

A20/5 TYPE WATERSTOP



They are waterstop tapes that can be used in low, medium and high expansion joints, shearing movements and structures exposed to high water pressure. They are named A20/5 and A25/5.

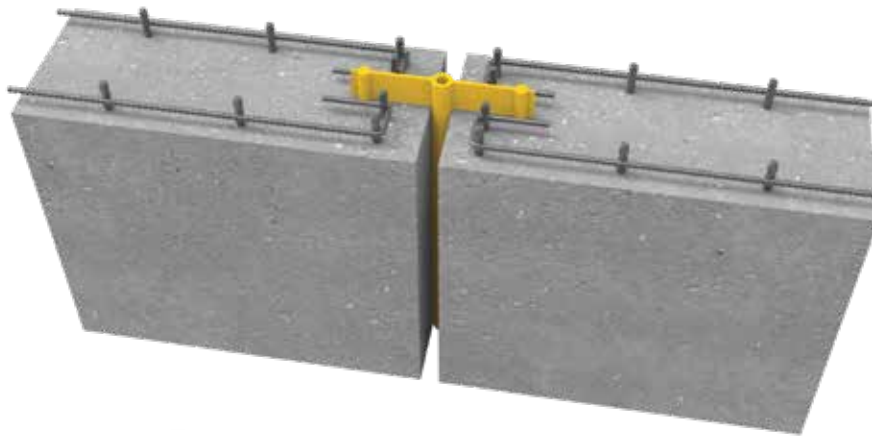

B TYPE WATERSTOP

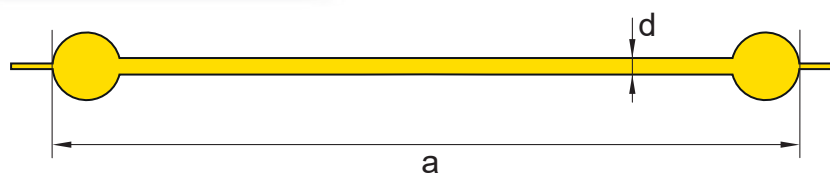

They are waterstop tapes used at low and high water pressure in full and partial contraction joints. It is referred to as B20/5 and B25/5. Production length is 20 meters.

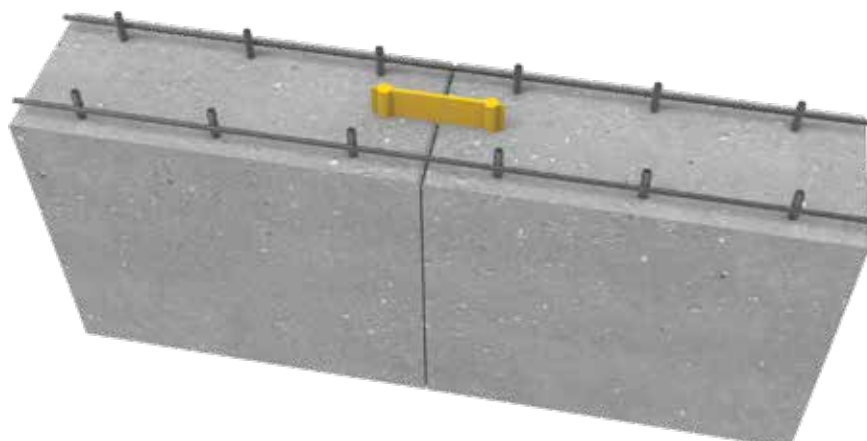

I TYPE WATERSTOP

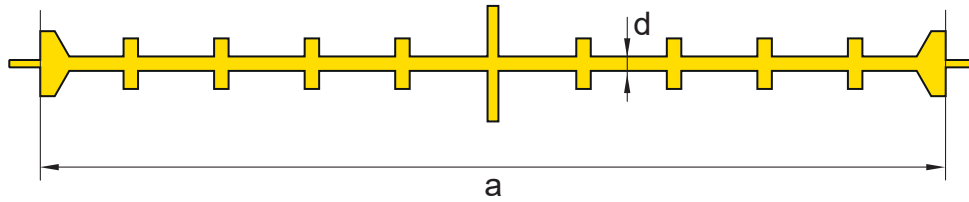

It is used in high or low water pressured contraction joints. Usually raft construction, raft construction to retaining wall and retaining wall to retaining structures can be the example applications areas of this tape. They are produced in various widths and lengths of 20 meters. It is referred to as I 25/5 ve I 20/4.

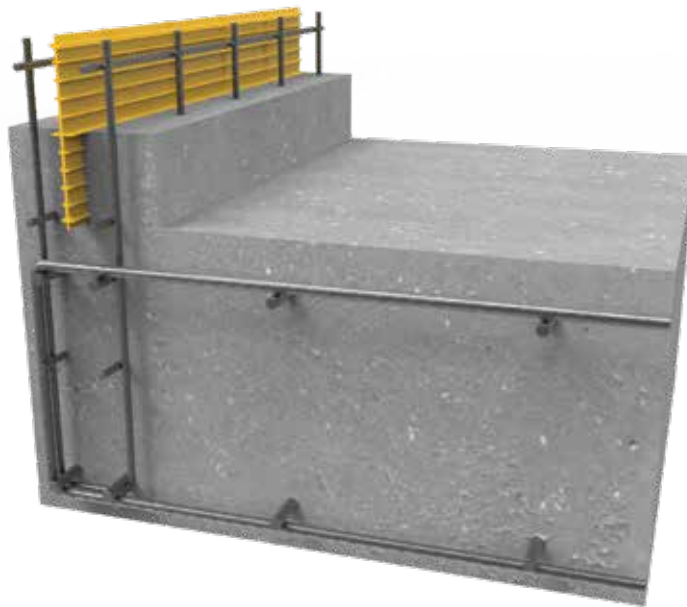

M TYPE WATERSTOP

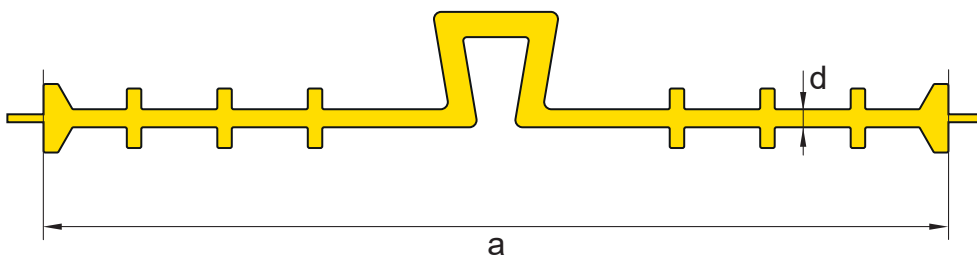

M type waterstop tapes are preferred to be used in high water pressure areas. It is defined as M25/5 and M20/5.



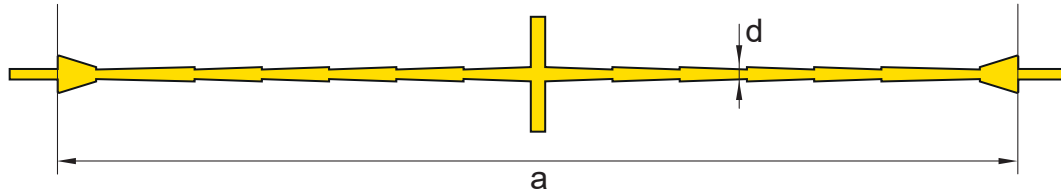



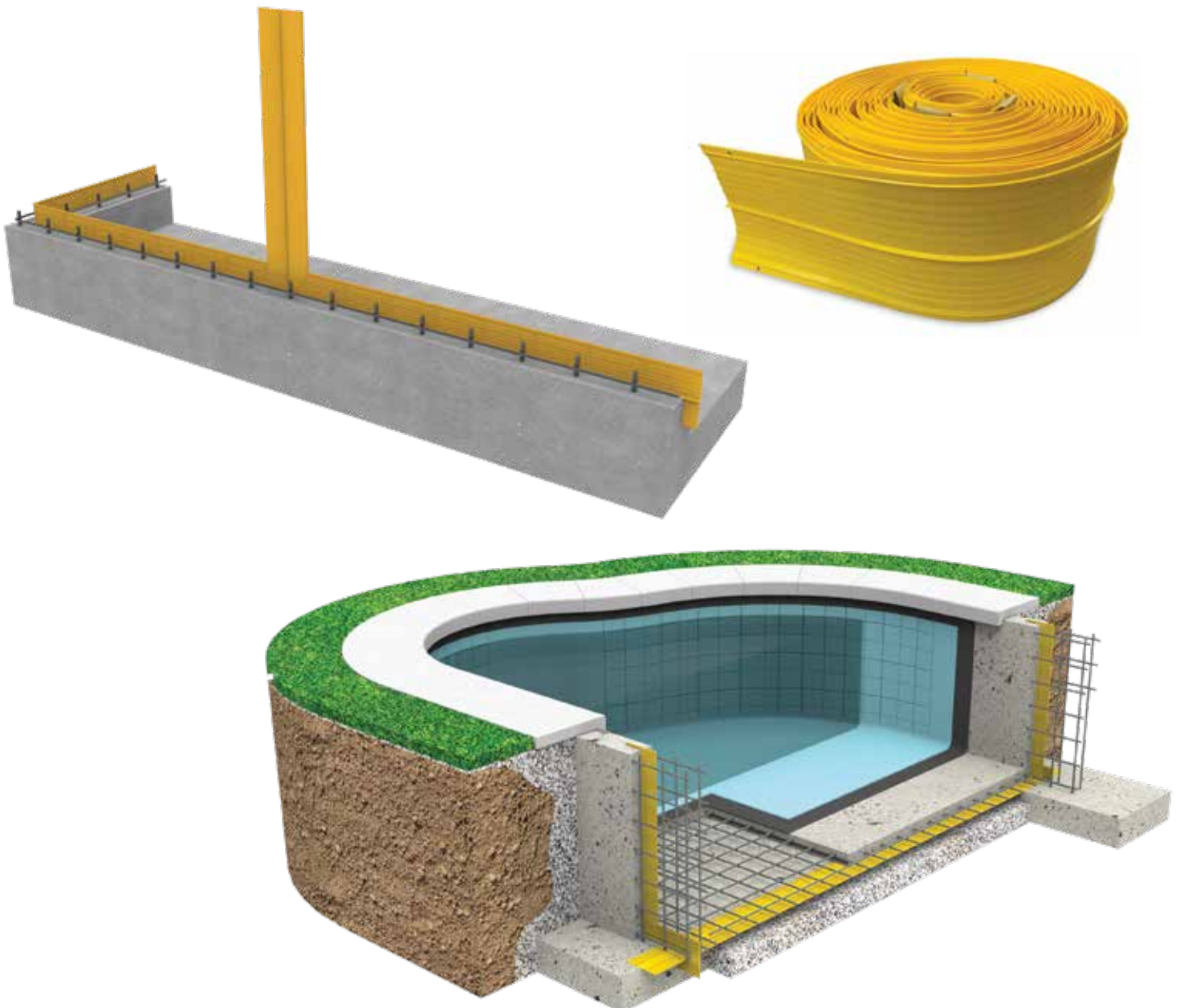

AK TYPE WATERSTOP



AK type waterstop tapes used in contraction joints and this economical system is preferred to be used in structures with low water pressure. Since its thickness is less than other types, it must be bonded very well so that it does not fold in the concrete. AK 20/2 is defined as AK 20/3. It is shipped in rolls of 20 meters.

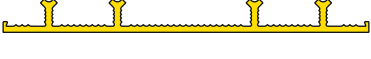
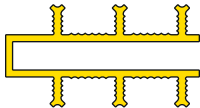

PVC WATERSTOP TYPES

TYPE	TECHNICAL DRAWING	WIDTH (cm)	THICKNESS (mm)	DESCRIPTION
A 20/5		20	5	20 CM WIDTH 5 MM THICKNESS "TYPE A" PVC WATERSTOP
I 20/4		20	4	20 CM WIDTH 4 MM THICKNESS "TYPE I" PVC WATERSTOP
I 20/5		20	5	20 CM WIDTH 5 MM THICKNESS "TYPE I" PVC WATERSTOP
I 25/5		25	5	25 CM WIDTH 5 MM THICKNESS "TYPE I" PVC WATERSTOP
B 25/5		25	5	25 CM WIDTH 5 MM THICKNESS "TYPE B" PVC WATERSTOP
AK 20/2		20	2,5	20 CM WIDTH 2,5 MM THICKNESS "TYPE AK" ECONOMIC PVC WATERSTOP
AK 20/3		20	3	20 CM WIDTH 3 MM THICKNESS "TYPE AK" PVC WATERSTOP
A 24/4		24	4	24 CM WIDTH 4 MM THICKNESS "TYPE A" PVC WATERSTOP
D 24/4		24	4	24 CM WIDTH 4 MM THICKNESS "TYPE D" PVC WATERSTOP
DA 24/4		24	4	24 CM WIDTH 4 MM THICKNESS "TYPE DA" PVC WATERSTOP
DA 32/4		32	4	32 CM WIDTH 4 MM THICKNESS "TYPE DA" PVC WATERSTOP
AA 24/4		24	4	24 CM WIDTH 4 MM THICKNESS "TYPE AA" PVC WATERSTOP
FA 90/5		9	5	9 CM WIDTH 5 MM THICKNESS "TYPE FA" PVC WATERSTOP

SODIUM BENTONITE BASED WATER SWELLING TAPE

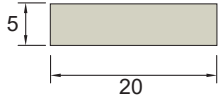

Hydroflex 20x5-B

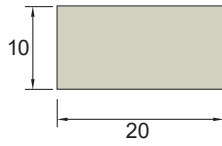

Hydroflex 20x10-B

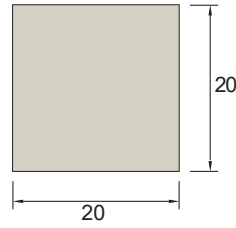

Hydroflex 20x20-B

It is a sodium bentonite and butyl rubber based waterstop tape that swells when in contact with water, filling the cracks, pores and capillary spaces in the concrete and makes the concrete waterproof.

- ✓ It is easy to work with and fast installation can be done.
- ✓ Can even easily be applied in excessive reinforcement areas.
- ✓ Joining the gap consists of bringing them side by side and pressing them.
- ✓ Since it swells in a controlled manner, it does not swell suddenly during concrete pouring.
- ✓ It can be used safely as it does not mix with drinking water.
- ✓ It is used in pool, foundation, tunnel, subway, retaining wall, garage, curtain concrete, water tank, sewerage, water treatment plant constructions, underground pipe and cable passages, concrete joints, dam, highway, junctions of old and new concrete.



ACRYLIC BASED WATER SWELLABLE TAPE

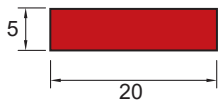

Hydroflex 20x5-A

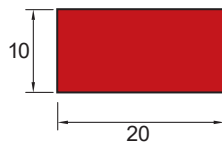

Hydroflex 20x10-A

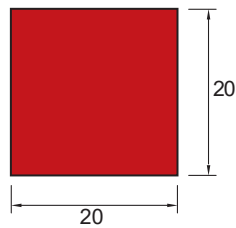

Hydroflex 20x20-A

It is an acrylic-based waterstop tape that swells when in contact with water. It can be used in pools, water tanks, treatment plants, construction joints, cold joints where Retaining walls connects with foundations and steel profiles and pipes come into contact with concrete. Also used in PVC pipe inlets and outlets, as a waterstop flange, to provide sealing in places exposed to sea water.

- ✓ It is easy to apply.
- ✓ It can be easily applied on many different surfaces.
- ✓ Easy application is made even in excess reinforcement.
- ✓ Controlled swelling does not swell suddenly in concrete pouring and does not damage the concrete.
- ✓ As it swells and changes its size, the material inside the reinforced concrete structure
- ✓ It creates a water barrier and fills possible gaps.
- ✓ It is resistant to high salt concentration and various chemicals.



HYDROFLEX TPE BASED WATER SWELLABLE TAPE

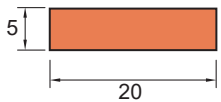
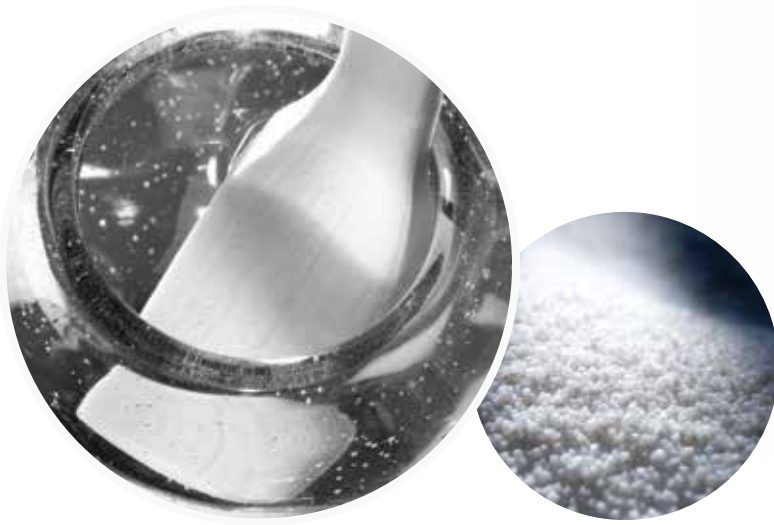

Hydroflex 20x5-T

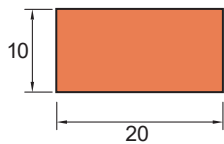

Hydroflex 20x10-T

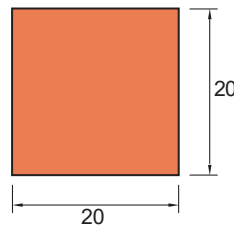

Hydroflex 20x20-T

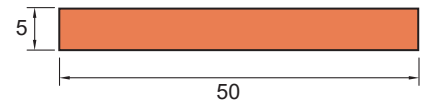

Hydroflex 50x5-T

TPE-based water-swellable tape is a type of tape that can expand even in 10% salt water, with an expansion rate of 350% to 850% elongation, and is resistant to many chemicals, does not disintegrate during swelling. The dimensions are 20x5, 20x10, 20x20 and 50x5 and are produced in rolls of 20 meters.

USAGE AREAS

- ✓ indoor and outdoor places
- ✓ In pools, water tanks, treatment plants
- ✓ At foundation - curtain joints, curtain - curtain joints
- ✓ In Tunnel Segments
- ✓ They are used in partial contraction and full contraction joints in all kinds of reinforced concrete and concrete structures.

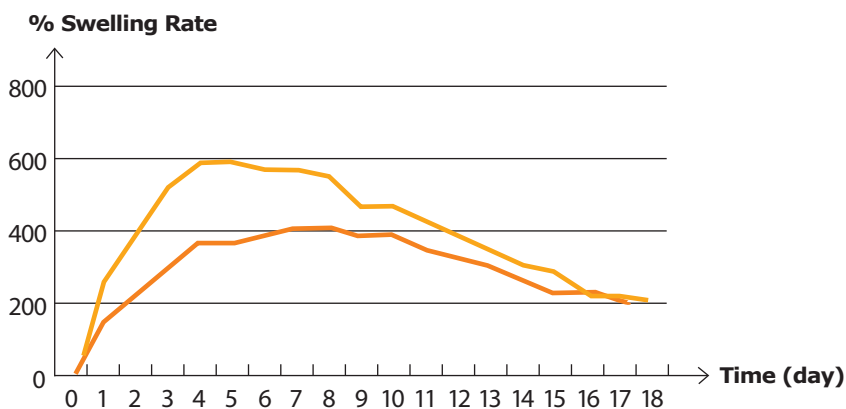

Tested with ionized water at 23°C

HOW DOES IT WORK?

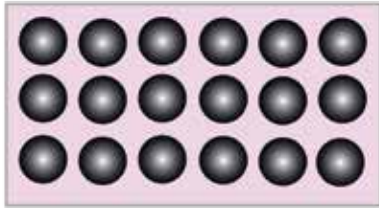

A special additive interacting with water is added to the TPE mixture during production.

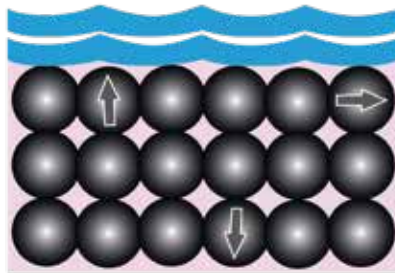

TPE expands uniformly and closes the gaps when the product stays in water or comes into contact with water.

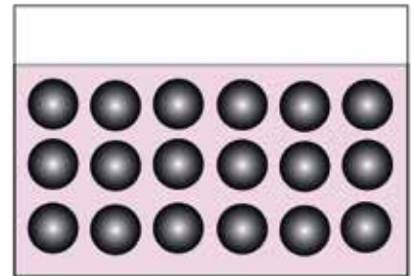

When the water source is withdrawn, the TPE mixture shrinks back to its original size and returns to its original size.

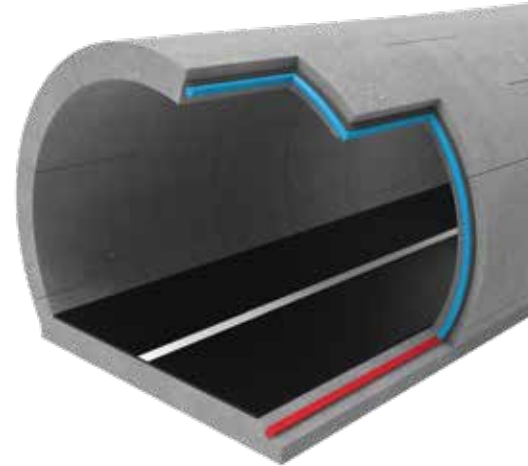

TPE BASED WATER SWELLABLE PLUGS

It is used for blocking the rod holes left during mold manufacturing on reinforced concrete and retaining walls with TPE based hydrophilic additives.

Hydroflex TK 01 is applied inside the plastic pipe remaining in the rod holes after reinforced concrete manufacturing. Prevents water leakage by swelling with water.

Hydroflex TK 02 is applied by placing it in the middle of the rod pipe during mold manufacturing. In case of contact with water over time, it swells and prevents water escape from these areas.

Around the Rod Pipe
Water Swelling Bracelet
Water Swelling Plug
Rigid PVC Plug

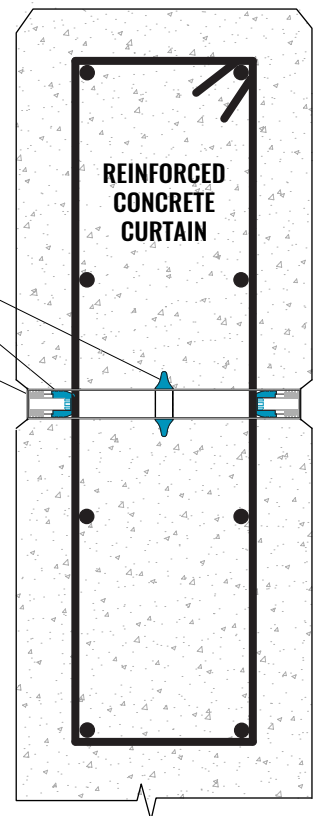

Hydroflex TK 01



Hydroflex TK 02

HYDROFLEX EXPANSION JOINT TAPES

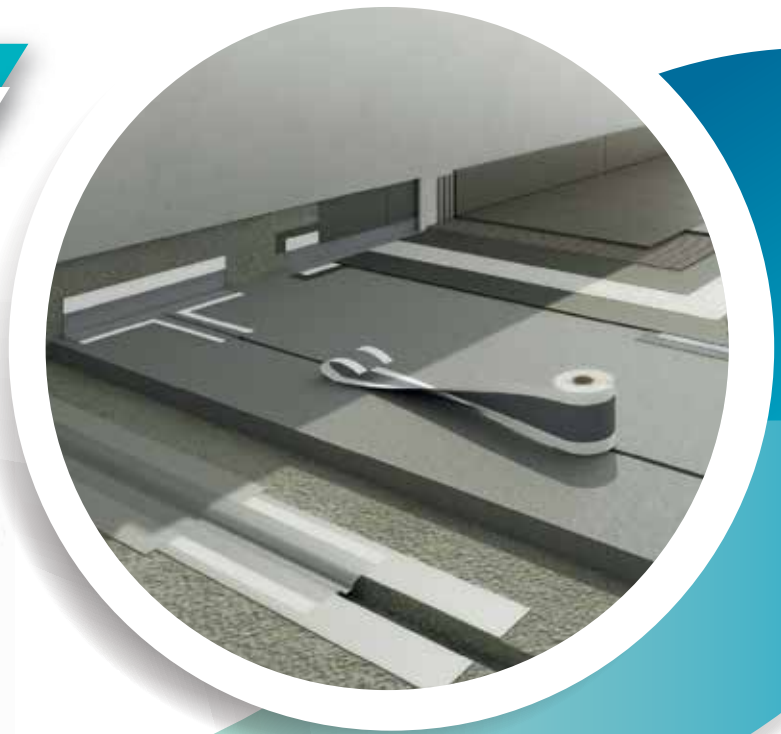

Hydroflex dilatation tapes are used to provide water insulation in existing or potential joints after concrete pouring.

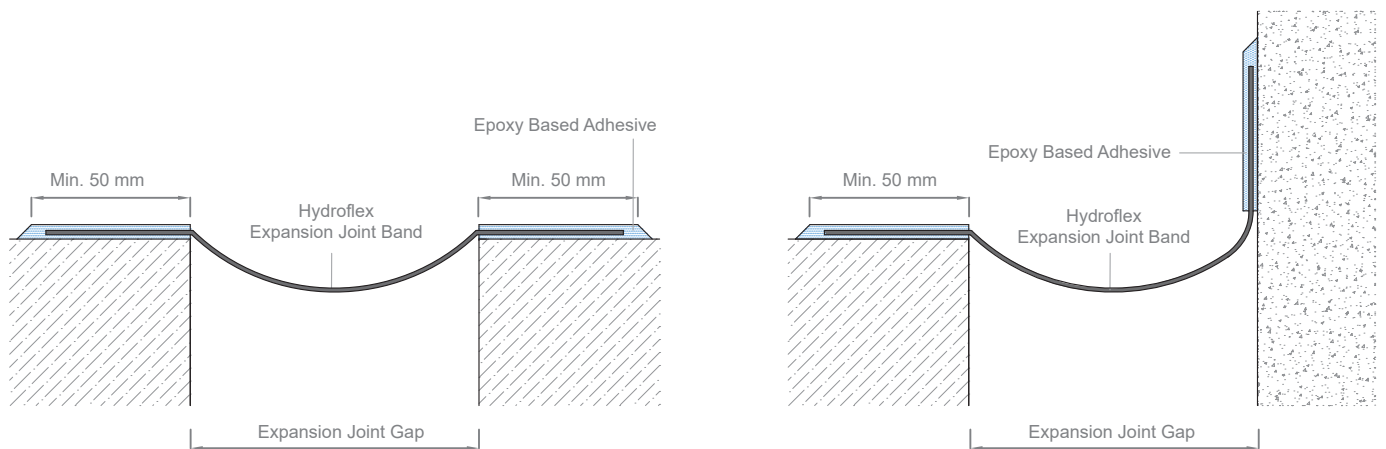

HYDROFLEX is a highly elastic dilatation tape used in the insulation of dilatation gaps, thermal expansion joints and cracks. It is produced in 150 mm - 200 mm - 250 mm - 300 mm - 400 mm widths with or without holes, in 1 mm, 1.50 and 2 mm thicknesses.

PRODUCT CODE	WIDTH	THICKNESS	LENGTH
HYDROFLEX 150	150	1 mm & 1,5 mm & 2 mm	25 mt / rulo
HYDROFLEX 200	200	1 mm & 1,5 mm & 2 mm	25 mt / rulo
HYDROFLEX 250	250	1 mm & 1,5 mm & 2 mm	25 mt / rulo
HYDROFLEX 300	300	1 mm & 1,5 mm & 2 mm	25 mt / rulo
HYDROFLEX 400	400	1 mm & 1,5 mm & 2 mm	25 mt / rulo

APPLICATION STAGES

1. STAGE



2. STAGE



3. STAGE



4. STAGE



HYDROFLEX FEATURES AND BENEFITS

1. Easy to apply with epoxy adhesive
2. Having a high elasticity of 600%
3. High bond strength
4. Resistance to vegetative roots
5. Resistance to ozone, diesel and oil
6. High performance in wide ranges such as -40°C and $+90^{\circ}\text{C}$
7. It has the characteristics of being able to be connected to each other by heat.

USAGE AREAS OF HYDROFLEX

1. In all building dilatations, horizontal and vertical applications
2. In the underground parts of the foundation and curtains
3. In structures such as wastewater treatment, drinking water, water tanks, pools
4. In tunnels and culverts
5. It is used in waterproofing applications of foundation and retaining wall joints.

HYDROFLEX TECHNICAL SPECIFICATIONS

CHEMICAL COMPOSITION	TPE (Termoplastik Elastomer)
COLOUR	Gri
HARDNESS LEVEL	80
SERVING TEMPERATURE VALUE	-40°C / $+90^{\circ}\text{C}$
THERMAL TEMPERATURE VALUE	270°C
ELONGATION AT BREAK	%600
TEAR STRENGTH	> 600N/cm
WATER PRESSURE RESISTANT VALUE	> 8 Bar
TENSILE STRENGTH	> 6 Mpa
UV RESISTANCE VALUE	> 7500 h
BITUMEN RESISTANCE	İyi
SULFURIC ACID RESISTANCE	İyi
ALCOHOL RESISTANCE	İyi
DETERGENT RESISTANCE	İyi

HYDROFLEX EPOXY ADHESIVE

It is an epoxy-based, two-component, repair, anchoring and bonding adhesive.

ADHESIVE USAGE AREAS

It is used in bonding dilatation tape, anchoring irons and bolts, insulating and repairing wide cracks.

ADHESIVE PROPERTIES AND BENEFITS

It has high adhesion strength, it is resistant to chemicals. Does not contain solvent. It is applied on floor, wall and terrace dilatations. Water and gas proof. It can be applied to damp surfaces. It has a soft consistency and is easy to apply.



HYDROFLEX CHAMFER BANDS

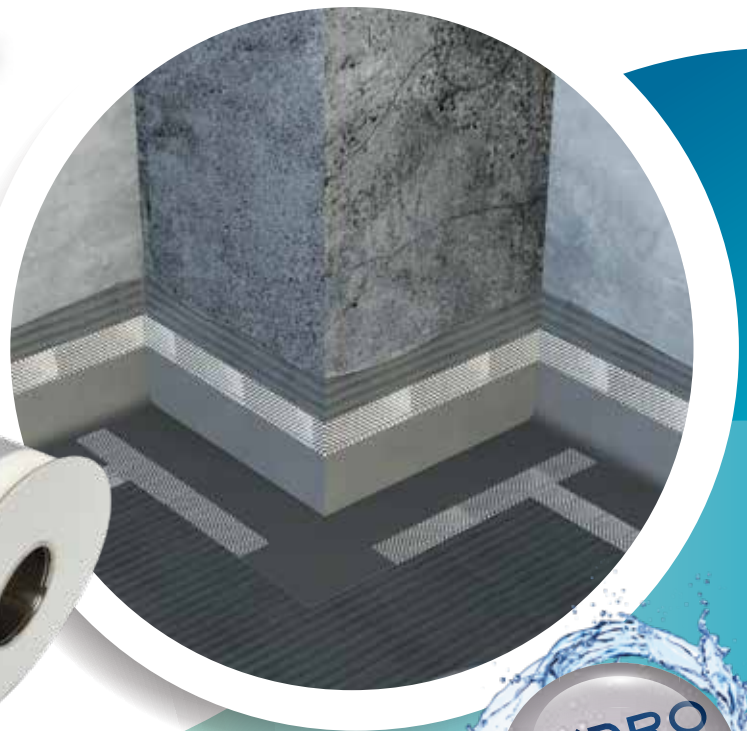

HYDRO
FLEX

Hydroflex 121
Felt Chamfer Tape

Hydroflex 120
Mesh Chamfer Tape

It is used to prevent cracks in inner and outer corner chamfers and to ensure continuity in sliding-based insulation applications in wet areas and terraces. It is shipped in rolls of 50 meters. Internal and external corners are available.

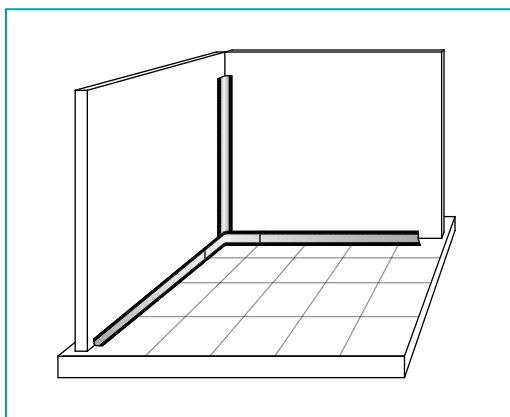

* The purpose of waterproofing in wet areas, floors and It is to stop the moisture that may occur on the walls and enable it to evaporate.

* Hydroflex Chamfer Tape is used in order to prevent cracks in the inner corners in case of using liquid waterproofing materials in wet areas.

* Liquid waterproof materials, which are normally flexible on flat surfaces, cannot tolerate discontinuity in case of cracks in the inner corners. Generally, these are the points where water seepage happens most commonly.

These sensitive areas should be isolated with special polyester tapes.

*After the Hydroflex chamfer tape is placed on the insulation adhesive, the top layer of adhesive should be applied again with in a 10 cm area.

* In order to provide a proper isolation, the continuity of the applied tape should be ensured. In addition, physical damage (tearing, impact, etc.) should be avoided while ceramic or other finishing materials are placed in place.



Hydroflex 120 İK - Internal Corner Element

Hydroflex 120 DK - External Corner Element

HYDROFLEX PU-150 POLYURETHANE SEALANT

It is a polyurethane based low modulus expansion joint filler. It is specially formulated to provide bubble-free curing even in very high temperature and humidity climatic conditions. It cures by reacting with the atmosphere. It adheres perfectly to the side surfaces. Hydroflex PU-150 is suitable for floor joints subject to foot traffic according to EN 15651-4.



USAGE AREAS

- ✓ Expansion Joint gaps
- ✓ Prefabricated building joints
- ✓ Water tanks and pools
- ✓ Irrigation channels
- ✓ Glass, granite, marble

FEATURES

- ✓ Excellent adhesion
- ✓ It does not form bubbles even in difficult conditions.
- ✓ It is perfectly thixotropic.
(It behaves like a flow when tension is present. When the tension is removed, the structure returns to its original state.)

HYDROFLEX PU-50 FC POLYURETHANE SEALANT

It is a polyurethane based, fast curing, thixotropic joint filler sealant. Hydroflex PU-50 FC is UV resistant. However, if an appearance desired to be a different color, it should be painted with an acrylic-based paint. Shelf life is one year. It is produced and shipped in the form of 600 CC sausage rolls.

FEATURES

- ✓ Very good adhesion to most surfaces without the need for a special primer.
- ✓ Excellent chemical resistance in structures such as swimming pools and treatment plants.
- ✓ Resistant to microorganisms and fungi.
- ✓ Applicable even under water.
- ✓ Excellent heat resistance can be applied even above 60°C.
- ✓ Resistant to cold remains elastic even at -40°C.

USAGE AREAS

- ✓ Thermal expansion joints
- ✓ Shrinkage joints
- ✓ Prefabricated building joints
- ✓ Aluminum window, panel edges
- ✓ Floor applications

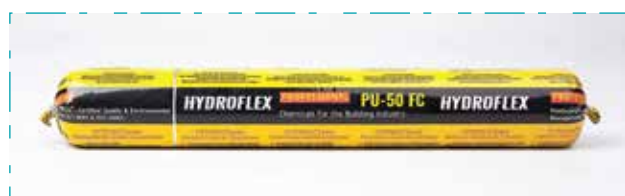



INSULATION PRESSURE PROFILE AND FINISH PROFILES

It is a product group that is used at the end points of insulation in all kinds of bituminous, pvc, tpo, tpe membrane applications and completes waterproofing. There are surface mounted and flush mounted models as well as wide flashing types are available.

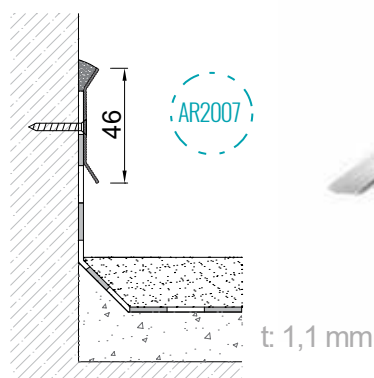
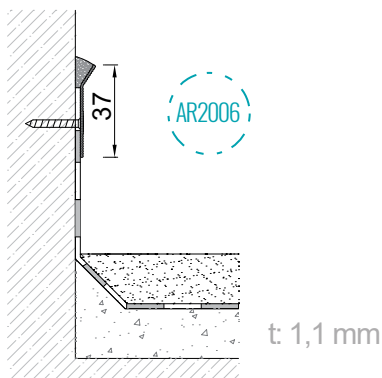
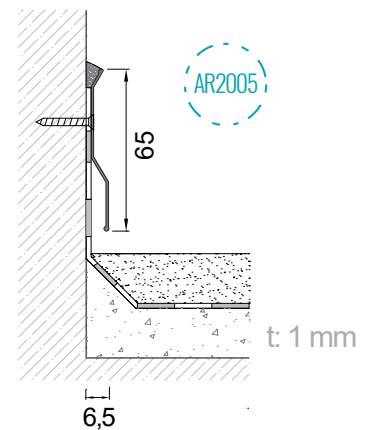
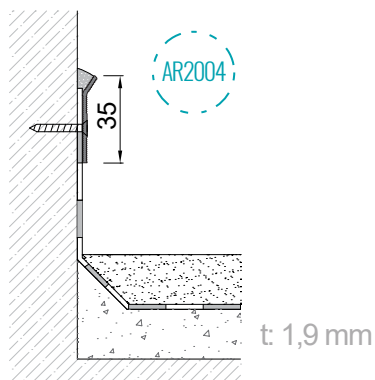
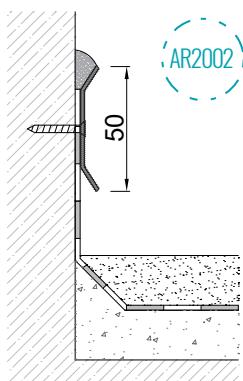

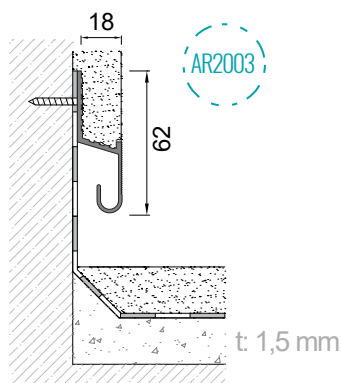
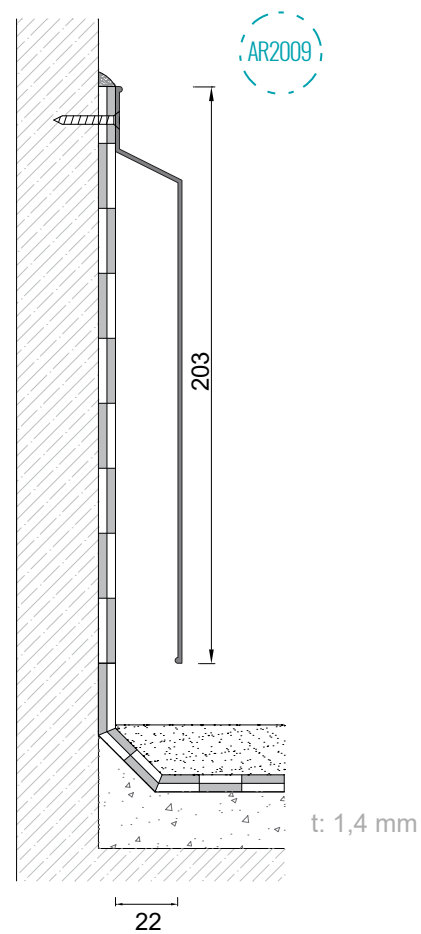
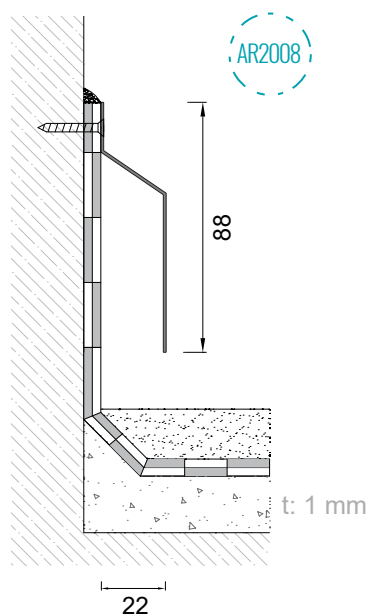
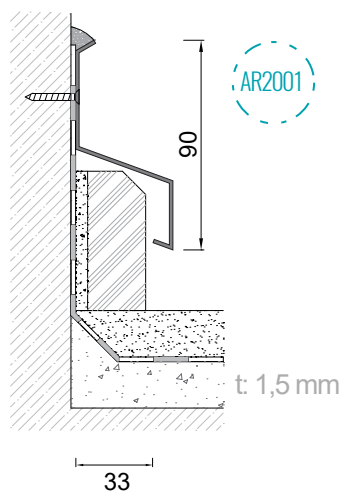



www.arfen.com



ARFEN İNŞAAT TAAHHÜT SAN. ve TİC. A.Ş.

Atatürk San. Bölgesi Ömerli Mah. Hakkı İleri Cad. Gülce Sk. No:22 Hadımköy - Arnavutköy / İSTANBUL
Tel: +90 212 485 16 15 - Fax: +90 212 771 25 79 İzmir: +90 232 459 72 71 - Ankara: +90 312 286 00 06

